

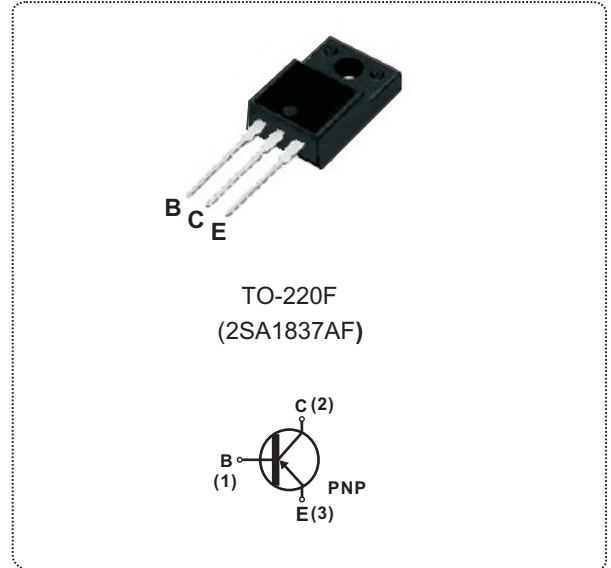
## High Frequency PNP Power Transistor -1A/-230V/20W

**FEATURES**

- High transition frequency:  
 $f_T = 70\text{MHz}$  (typ.)
- Complementary to 2SC4793AF
- TO-220F package which can be installed to the heat sink with one screw

**APPLICATIONS**

- Power amplifier
- Driver stage amplifier


**ABSOLUTE MAXIMUM RATINGS ( $T_C = 25^\circ\text{C}$  unless otherwise specified)**

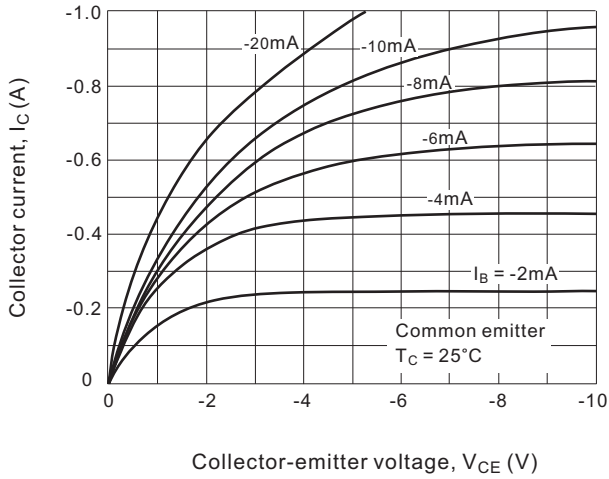
SYMBOL	PARAMETER	TEST CONDITIONS	VALUE	UNIT
$V_{CBO}$	Collector to base voltage		-230	V
$V_{CEO}$	Collector to emitter voltage	$I_B=0$	-230	
$V_{EBO}$	Emitter to base voltage	$I_C=0$	-5	
$I_C$	Collector current-continuous		-1	A
$I_{CM}(I_{CP})$	Peak collector current	$t_p < 5\text{ ms}$	-2	
$I_B$	Base Current		-0.1	
$P_C$	Collector power dissipation	$T_C=25^\circ\text{C}$	20	W
		$T_a=25^\circ\text{C}$	2.0	
$T_J$	Junction temperature		150	$^\circ\text{C}$
$T_{STG}$	Storage temperature		-55 to 150	

**ELECTRICAL CHARACTERISTICS ( $T_C = 25^\circ\text{C}$  unless otherwise specified)**

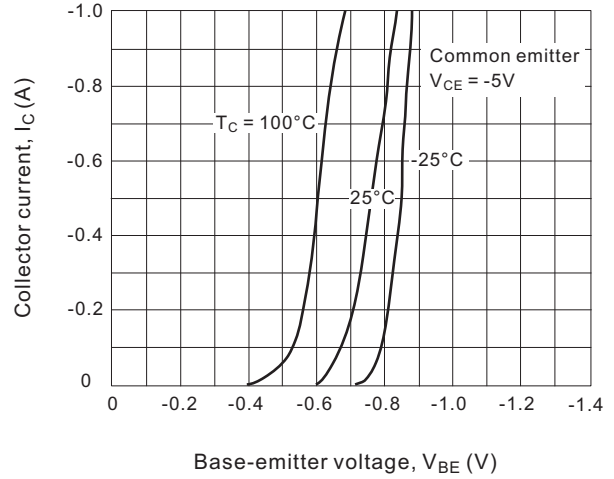
SYMBOL	PARAMETER	TEST CONDITIONS	Min.	Typ.	Max.	UNIT
$I_{CBO}$	Collector cutoff current	$V_{CBO}=-230\text{V}, I_E=0$	$T_C=25^\circ\text{C}$		-1.0	$\mu\text{A}$
			$T_C=125^\circ\text{C}$		-100	
$I_{EBO}$	Emitter cutoff current	$V_{EBO} = -5\text{V}, I_C=0$			-1.0	
$V_{(BR)CEO}$	Collector to emitter breakdown voltage	$I_B=0, I_C = -100\text{mA}$	-230			V
$V_{CE(sat)*}$	Collector to emitter saturation voltage	$I_C = -0.5\text{A}, I_B = -50\text{mA}$			-1.5	
$V_{BE}$	Base to emitter voltage	$I_C = -0.5\text{A}, V_{CE} = -5\text{V}$			-1.0	
$h_{FE*}$	Forward current transfer ratio (DC current gain)	$I_C = -0.1\text{A}, V_{CE} = -5\text{V}$	100		320	
$f_T$	Transition frequency	$V_{CE} = -10\text{V}, I_C = -100\text{mA}$		70		MHz
$C_{ob}$	Collector output capacitance	$V_{CB} = -10\text{V}, I_E=0, f=1\text{MHz}$		30		pF

\*Pulsed: Pulse duration= 300 $\mu\text{s}$ , duty cycle= 1.5%.

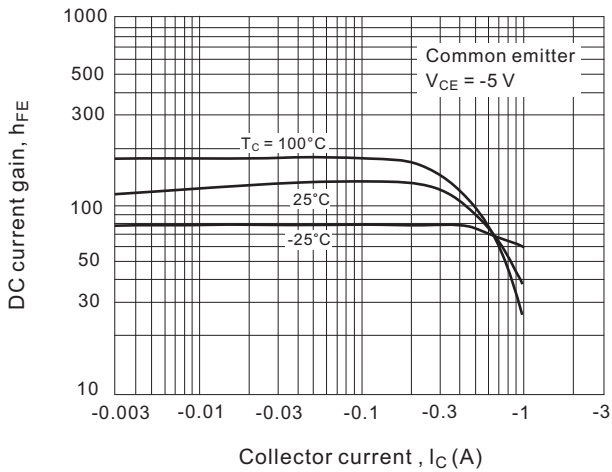
**Fig.1  $I_C$ - $V_{CE}$  Characteristics**



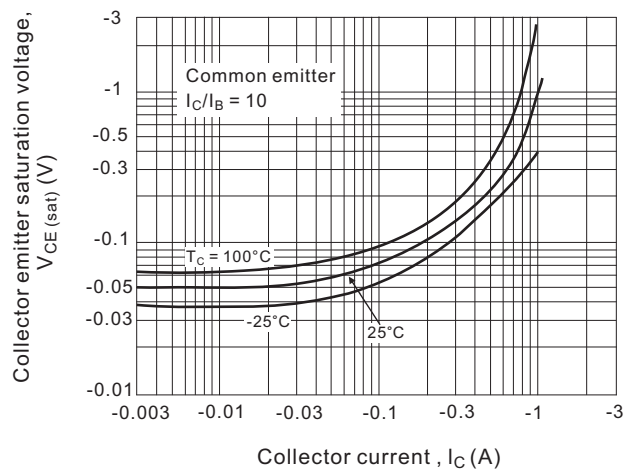
**Fig.2  $I_C$ - $V_{BE}$  Temperature characteristics**



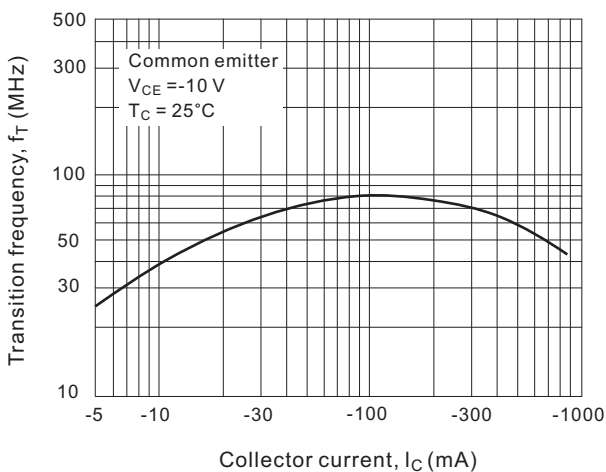
**Fig.3  $h_{FE}$ - $I_C$  Characteristics**



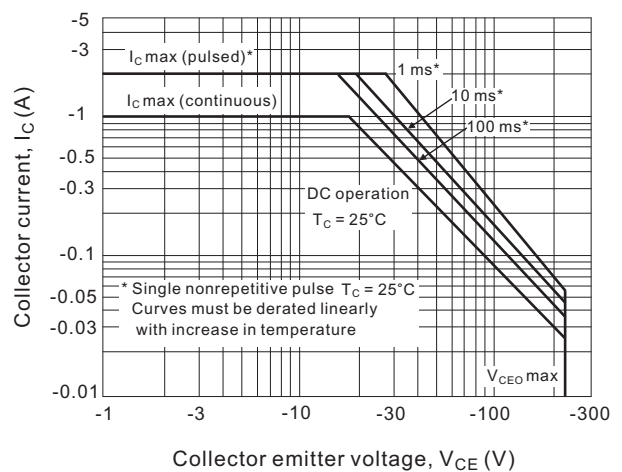
**Fig.4  $V_{CE(sat)}$  -  $I_C$  Temperature characteristics**



**Fig.5  $f_T$ - $I_C$  Characteristics**

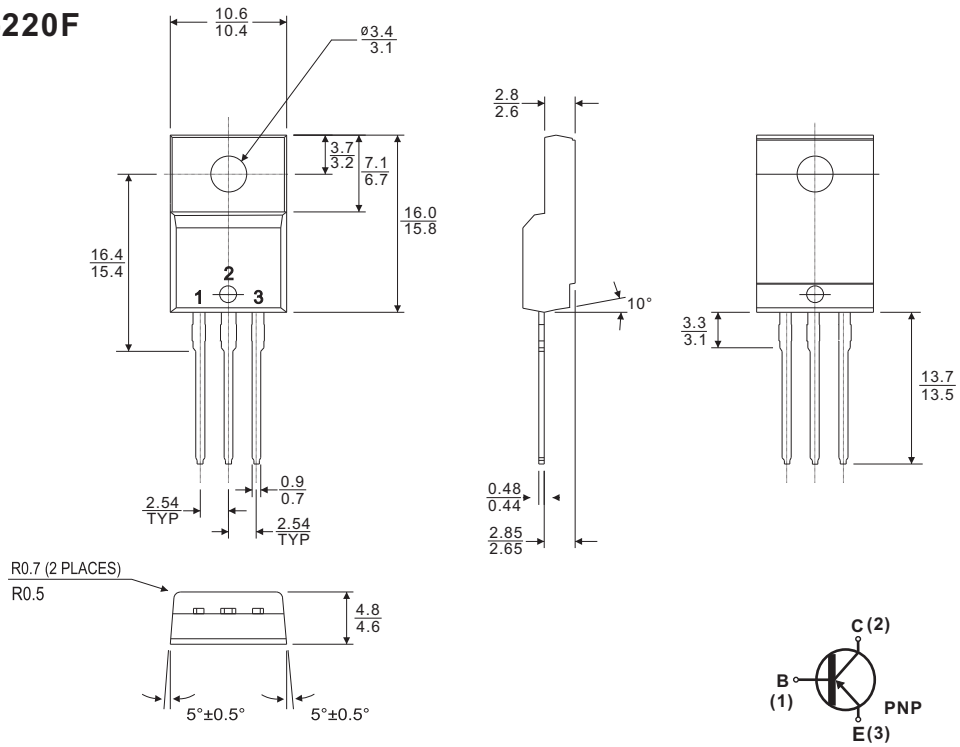


**Fig.6 Safe operating area (SOA)**



**Case Style**

**TO-220F**



All dimensions in millimeters